

Heat recovery from air compressors

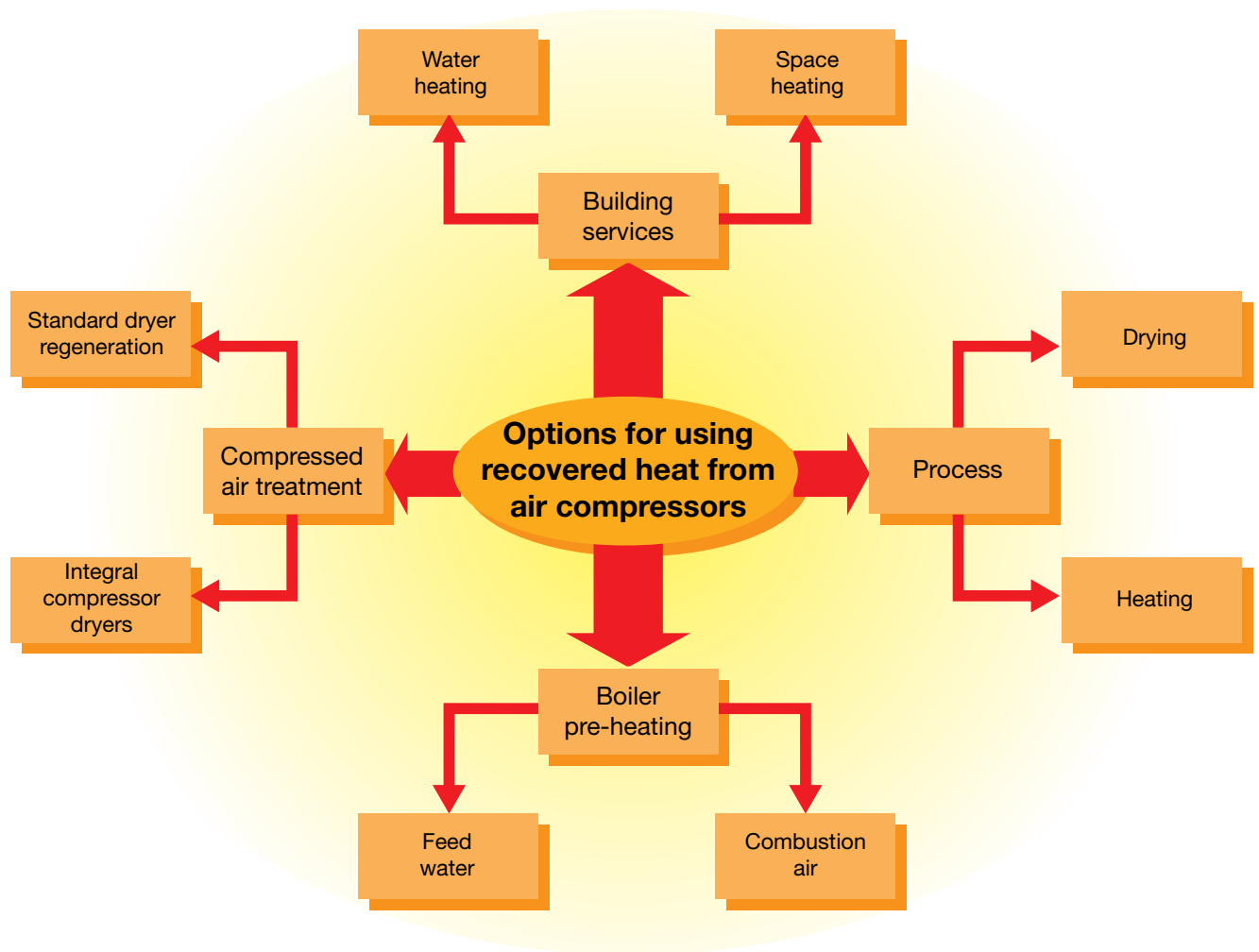

ENERGY EFFICIENCY

BEST PRACTICE PROGRAMME

HEAT RECOVERY FROM AIR COMPRESSORS

This Guide is No 238 in the Good Practice Guide series. The Guide offers advice on practical ways of recovering and utilising waste heat from air compressors. It provides an outline procedure for assessing the likely benefits of recovering heat by matching the waste heat available with the real demand for heat. Case studies are also included which show the savings that can be achieved in practice.

Prepared for the Department of the Environment, Transport and the Regions by:

ETSU
Harwell
Didcot
Oxfordshire
OX11 0RA

and

Air Technology Ltd
6/7 Falcon Street
Loughborough
Leicestershire
LE11 1EH

with

Building Energy Solutions
Woodborough House
10 Walkfield Drive
Epsom, Surrey
KT18 5UF

ETSU acknowledges the following organisations for their help in compiling this Guide:

Atlas Copco
CompAir BroomWade
Ingersoll Rand
HPC Compressed Air Systems

© Crown copyright 1998
First published March 1998

List of relevant Good Practice Guides

1. GUIDANCE NOTES FOR THE IMPLEMENTATION OF SMALL-SCALE PACKAGED COMBINED HEAT AND POWER
3. INTRODUCTION TO SMALL-SCALE COMBINED HEAT AND POWER
13. GUIDANCE NOTES FOR THE IMPLEMENTATION OF HEAT RECOVERY FROM HIGH TEMPERATURE WASTE GAS STREAMS
18. REDUCING ENERGY CONSUMPTION COST BY STEAM METERING
30. ENERGY EFFICIENT OPERATION OF INDUSTRIAL BOILER PLANT
31. COMPUTER AIDED MONITORING AND TARGETING FOR INDUSTRY
36. COMMERCIAL REFRIGERATION PLANT: ENERGY EFFICIENT OPERATION AND MAINTENANCE
37. COMMERCIAL REFRIGERATION PLANT: ENERGY EFFICIENT DESIGN
38. COMMERCIAL REFRIGERATION PLANT: ENERGY EFFICIENT INSTALLATION
42. INDUSTRIAL REFRIGERATION PLANT: ENERGY EFFICIENT OPERATION AND MAINTENANCE
43. INTRODUCTION TO LARGE-SCALE COMBINED HEAT AND POWER
44. INDUSTRIAL REFRIGERATION PLANT: ENERGY EFFICIENT DESIGN
59. ENERGY EFFICIENT DESIGN AND OPERATION OF REFRIGERATION COMPRESSORS
69. INVESTMENT APPRAISAL FOR INDUSTRIAL ENERGY EFFICIENCY
83. ENERGY EFFICIENT LIQUID RING VACUUM PUMP INSTALLATIONS IN THE PAPER INDUSTRY
84. MANAGING AND MOTIVATING STAFF TO SAVE ENERGY
85. ENERGY MANAGEMENT TRAINING
88. ENERGY EFFICIENT USE OF BOILERS USING CHAIN GRATE STOKERS
89. GUIDE TO COMPACT HEAT EXCHANGERS
90. ENERGY EFFICIENCY IN THE PROVISION AND USE OF INDUSTRIAL GASES
91. MONITORING AND TARGETING IN LARGE MANUFACTURING COMPANIES
115. AN ENVIRONMENTAL GUIDE TO SMALL-SCALE COMBINED HEAT AND POWER
116. ENVIRONMENTAL ASPECTS OF LARGE-SCALE COMBINED HEAT AND POWER
126. COMPRESSING AIR COSTS
141. WASTE HEAT RECOVERY IN THE PROCESS INDUSTRIES
149. ROTARY DRYING IN THE FOOD AND DRINK INDUSTRY
163. ENERGY EFFICIENT PULPING/SLUSHING IN PAPER MANUFACTURE
164. ENERGY EFFICIENT OPERATION OF KILNS IN THE CERAMIC INDUSTRIES
168. CUTTING YOUR ENERGY COSTS
169. TOTAL QUALITY MANAGEMENT
170. REDUCING WATER PUMPING COSTS IN THE STEEL INDUSTRY
178. CUTTING THE COSTS OF REFRIGERANT LEAKAGE
181. ENERGY EFFICIENT CRUSHING AND GRINDING SYSTEMS
185. SPRAY DRYING
197. ENERGY EFFICIENT HEAT DISTRIBUTION
213. SUCCESSFUL PROJECT MANAGEMENT FOR ENERGY EFFICIENCY
214. MAKING USE OF BUSINESS STANDARDS
215. REDUCING ENERGY COSTS IN INDUSTRY WITH ADVANCED COMPUTING AND CONTROL
217. CUTTING ENERGY LOSSES THROUGH EFFECTIVE MAINTENANCE (TOTALLY PRODUCTIVE OPERATIONS)
227. HOW TO APPRAISE CHP

Copies of these guides may be obtained from:

Energy Efficiency Enquiries Bureau
ETSU
Harwell
Didcot
Oxfordshire
OX11 0RA

Tel No: 01235 436747. Fax No: 01235 433066. E-mail: etsuenq@aeat.co.uk

Overseas customers please remit £3 per copy (minimum of £6) with order to cover cost of packaging and posting. Please make cheques, drafts or money orders payable to ETSU.

FOREWORD

This Guide is part of a series produced by the Government under the Energy Efficiency Best Practice Programme. The aim of the programme is to advance and spread good practice in energy efficiency by providing independent, authoritative advice and information on good energy efficiency practices. Best Practice is a collaborative programme targeted towards energy users and decision makers in industry, the commercial and public sectors, and building sectors including housing. It comprises four inter-related elements identified by colour-coded strips for easy reference:

- *Energy Consumption Guides*: (blue) energy consumption data to enable users to establish their relative energy efficiency performance;
- *Good Practice Guides*: (red) and *Case Studies*: (mustard) independent information on proven energy-saving measures and techniques and what they are achieving;
- *New Practice projects*: (light green) independent monitoring of new energy efficiency measures which do not yet enjoy a wide market;
- *Future Practice R&D support*: (purple) help to develop tomorrow's energy efficiency good practice measures.

If you would like any further information on this document, or on the Energy Efficiency Best Practice Programme, please contact the Environment and Energy Helpline on 0800 585794. Alternatively, you may contact your local service deliverer – see contact details below.

ENGLAND

London

Govt Office for London
6th Floor
Riverwalk House
157-161 Millbank
London
SW1P 4RR
Tel 020 7217 3435

East Midlands

The Sustainable Development Team
Govt Office for the East Midlands
The Belgrave Centre
Stanley Place
Talbot Street
Nottingham
NG1 5GG
Tel 0115 971 2476

North East

Sustainability and Environment Team
Govt Office for the North East
Wellbar House
Gallowgate
Newcastle-upon-Tyne
NE1 4TD
Tel 0191 202 3614

North West

Environment Team
Govt Office for the North West
Cunard Building
Pier Head
Water Street
Liverpool
L3 1QB
Tel 0151 224 6401

South East

Sustainable Development Team
Govt Office for the South East
Bridge House
1 Walnut Tree Close
Guildford
Surrey
GU1 4GA
Tel 01483 882532

East

Sustainable Development Awareness Team
Govt Office for the East of England
Heron House
49-53 Goldington Road
Bedford
MK40 3LL
Tel 01234 796194

South West

Environment and Energy Management Team
Govt Office for the South West
The Pithay
Bristol
Avon
BS1 2PB
Tel 0117 900 1700

West Midlands

Regional Sustainability Team
77 Paradise Circus
Queensway
Birmingham
B1 2DT
Tel 0121 212 5300

Yorkshire and the Humber

Sustainable Development Unit
Govt Office for Yorks and the Humber
PO Box 213
City House
New Station Street
Leeds
LS1 4US
Tel 0113 283 6376

NORTHERN IRELAND

IRTU Scientific Services
17 Antrim Road
Lisburn
Co Antrim
BT28 3AL
Tel 028 9262 3000

SCOTLAND

Energy Efficiency Office
Enterprise and Lifelong Learning Dept
2nd Floor
Meridian Court
5 Cadogan Street
Glasgow
G2 6AT
Tel 0141 242 5835

WALES

Business and Environment Branch
National Assembly for Wales
Cathays Park
Cardiff
CF10 3NQ
Tel 029 2082 5172

CONTENTS

Section		Page No.
1.	INTRODUCTION	1
1.1	The Benefits of Heat Recovery	2
1.2	Identifying the Heat Recovery Options	3
1.3	The Feasibility Study	5
2.	TYPES OF COMPRESSOR (THE HEAT SOURCE)	6
2.1	Estimating the Available Heat from a Compressor Installation	6
3.	POTENTIAL USES FOR HEAT (THE HEAT SINK)	10
3.1	Estimating the Demand for Heat	10
3.2	Recovering Heat for Space Heating	11
3.3	Recovering Heat for Hot Water	13
3.4	Recovering Heat for Boiler Pre-heating	15
3.5	Recovering Heat to Supply Process Loads	17
3.6	Compressed Air Treatment	17
4.	MATCHING THE HEAT SOURCE AND SINK	18
4.1	Heat Quantities and Temperatures	19
4.2	Times	19
4.3	Location	19
5.	ESTIMATING THE ECONOMICS	21
5.1	Estimating the Payback Period	21
5.2	Worked Examples of Payback Calculation	22
6.	CASE STUDIES OF PRACTICAL HEAT RECOVERY INSTALLATIONS	24
6.1	Case History 1: David Brown Radicon plc, Sunderland	24
6.2	Case History 2: GPT Ltd, Liverpool	24
6.3	Case History 3: Caradon MK Electric Ltd, St Asaph	25
6.4	Case History 4: SGB Youngman, Slinfold	25
6.5	Case History 5: Cookson Matthey Ceramics & Minerals Ltd, Tyne & Wear	25
6.6	Case History 6: Short Brothers plc, Belfast	26
6.7	Case History 7: Baxter Healthcare Ltd, Thetford	26
6.8	Case History 8 - Site: GSPK Circuits Ltd., Knaresborough	27

FIGURES

Fig 1	Energy flow in a typical oil-injected screw compressor	1
Fig 2	Options for recovering the heat	4
Fig 3	The stages of a heat recovery feasibility study	5
Fig 4	Typical small air-cooled compressor with direct heat recovery	12
Fig 5	Typical large air-cooled compressor with direct heat recovery	13
Fig 6	Using a heat exchanger to recover hot water	14
Fig 7	A sophisticated oil-to-water heat recovery system	15
Fig 8	Direct forced draft boiler intake of hot air	16
Fig 9	Indirect boiler intake of hot air	16
Fig 10	Matching heat demand and heat availability	18
Fig 11	Example of matching source and demand	22

TABLES

Table 1	Value of heat available from air-cooled rotary screw compressors	2
Table 2	Worked Example 1	23
Table 3	Worked Example 2	23

1. INTRODUCTION

While over 90% of the energy input to compressors is lost as heat, it is usually at a relatively low grade for process work. It is, however, commonly at temperatures suitable for building services and other applications. Recovering this heat can prove highly cost-effective, reducing overall energy bills and also benefiting the environment.

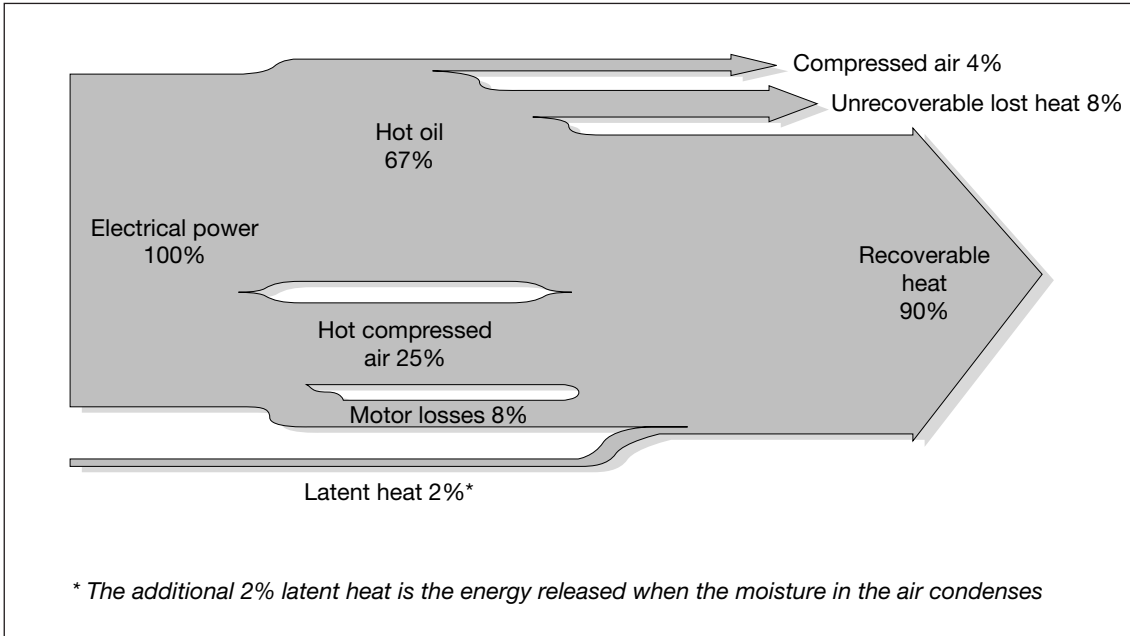

Fig 1 Energy flow in a typical oil-injected screw compressor

In practice, air-cooled compressors can provide hot air at up to 80°C and water-cooled compressors can provide hot water at up to 95°C. A typical air compressor of 47 l/s (100 cfm) capacity consumes 22 kW at full load, of which almost 20 kW can be recovered as heat. If the recovered heat displaces electric heating, the effective cost of generating compressed air will fall by up to 90%. Where the displaced fuel source is a cheaper fossil fuel, such as fuel oil or gas, considerable cost savings can still be made, even though the actual value of the displaced fuel will be less than that of the electricity used.

This Good Practice Guide describes the methods by which heat can be recovered from various configurations of compressor. It is intended for air compressor users who are interested in practical applications of heat recovery, and for building services/production engineers looking to reduce heating costs by recovering heat from air compressors. Unless otherwise stated, all references in this Guide are for 7 barg, since most industrial compressed air is used at this pressure.

Heat recovery is not the main purpose of an air compressor system and it should not affect the normal operation of the compressor.

All installations are different and this Guide cannot fully cover the practical design details for each individual installation. If at all unsure, consult the air compressor supplier before modifying your compressor's cooling system.

1.1 The Benefits of Heat Recovery

Significant energy cost savings can be made by recovering heat from air compressors. In general, the capital cost of the additional equipment necessary to recover the waste heat is relatively modest, providing a quick return on investment. In some cases, heat recovery systems can displace heating or hot water systems entirely, thus reducing overall capital costs.

Where the heat can be fully utilised, simple payback periods of under two years are frequently achieved.

Table 1 gives details of the heat available from a range of air-cooled rotary screw packaged compressors.

Table 1 Value of heat available from air-cooled rotary screw compressors

Capacity l/s (cfm)	Nominal motor rating (kW)	Cooling air flow (l/s)	Heat available kW	Gas equivalent £/year (Gas at 0.8p/kWh)		Electricity equivalent £/year (Electricity 4.5p/kWh)	
				48 hours per week	168 hours per week	48 hours per week	168 hours per week
40 (85)	15	450	12.7	339	1,187	1,426	4,993
60 (128)	22	810	21	561	1,963	2,359	8,256
159 (337)	55	1600	53.5	1,429	5,001	6,009	21,032
314 (665)	110	3700	107	2,858	10,002	12,018	42,064
450 (953)	160	5600	157	4,193	14,676	17,634	61,720
585 (1,240)	200	8900	197	5,261	18,415	22,127	77,445
725 (1,535)	250	8900	246	6,570	22,995	27,631	96,708

Data in Table 1 assume the compressor is operating at 7 barg and at full load, and that gas boiler efficiency is 75%. Note that the differing cooling air flows to compressor rating provide for different cooling air temperature rises.

Example of savings made by the installation of a heat recovery system

An air-cooled 159 l/s (337 cfm) compressor with a 55 kW motor driving the compressor shaft and cooling fan dissipates 53.5 kW at full load. If the machine is on duty for 48 hours per week, 52 weeks per year, the total quantity of recoverable heat would be 133,536 kWh/year. Using the recovered heat to displace gas heating at a cost of 1.07p/kWh (taking a boiler efficiency of 75%) would give total annual savings of around £1,430. The cost of providing ducting and booster fans will depend on the site and the compressor location. If the compressor were located within the area to be heated, there may be no extra capital cost for recovering the heat. However, a typical ducting installation might cost £2,500, giving a simple payback period of roughly 1.75 years.

In addition to financial savings, installing a heat recovery system also provides wider benefits. Saving energy can produce substantial reductions in emissions to atmosphere, particularly CO₂. The reduction in CO₂ emissions will depend on the fuel that is displaced, e.g. burning natural gas emits 0.21 kg CO₂/kWh.

Example of CO₂ reduction after installation of a heat recovery system

If 133,536 kWh/year of heat is recovered and used for space heating purposes, displacing heat from a gas boiler, the annual reduction in CO₂ emissions will be approximately:

$$133,536 \times 0.21 = 28 \text{ tonnes CO}_2$$

1.2 Identifying the Heat Recovery Options

A whole range of heat recovery options is available. Identifying the most suitable for your application will depend on:

- the requirement for heat;
- the type of compressor cooling.

Building services often provide the most likely heat recovery option, generally involving ducting hot air from air-cooled machines to provide factory space heating or using a heat exchanger on water-cooled machines to heat water. Usually, the more simple the system, the more cost-effective it will prove.

Plotting monthly fuel bills provides a useful picture of current energy consumption and potential savings. Space heating demand is seasonal, whereas hot water load is relatively constant. Hot water heat recovery systems can therefore save energy all year round, although the heat demands are generally much smaller than for space heating.

Medium available		
	Hot Air	Hot Water
	<p>Generally smaller reciprocating, screw and vane machines (Air cooled)</p>	<p>Generally larger centrifugal, reciprocating, and screw machines (Water-cooled or heat exchanger on air-cooled machines)</p>
Building Services (see Sections 3.2 and 3.3)	Space heating 	Water heating
		Space heating
Process (see Section 3.5)	Process drying 	Process heating
Compressed Air Treatment (see Section 3.6)	Drying compressed air 	Drying compressed air
Boiler Pre-heating (see Section 3.4)	Pre-heating combustion air 	Pre-heating boiler make-up water

Fig 2 Options for recovering the heat

1.3 The Feasibility Study

A feasibility study, however brief, must be carried out to ensure the viability of a proposed heat recovery installation. Fig 3 shows the stages involved in a feasibility study and the relevant Section of this Guide in which they are covered.

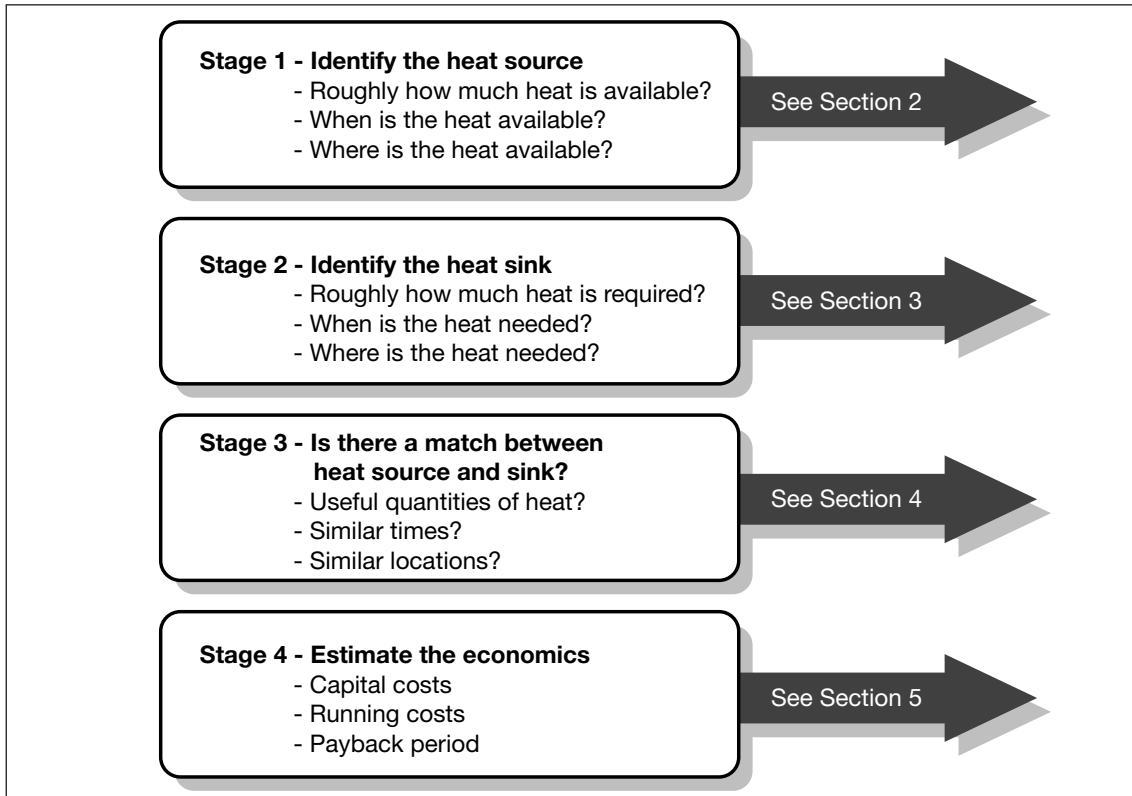

Fig 3 The stages of a heat recovery feasibility study

2. TYPES OF COMPRESSOR (THE HEAT SOURCE)

Stage 1 - IDENTIFY THE HEAT SOURCE

- Roughly how much heat is available?
- When is the heat available?
- Where is the heat available?

There are several configurations of air compressor in operation throughout industry, some cooled by water, others by air. In practice, it is not cost-effective to invest capital in heat recovery systems for compressors smaller than 15 kW.

The prime purpose of an air compressor is to compress air efficiently. The use of a poorly designed heat recovery system can detract from the basic cooling of the machine, reducing its efficiency and reliability and thus negating any savings made from heat recovery. **Heat recovery is a by-product and not the primary function of the compressor.**

Heat recovery will give the most effective payback when designed as part of the compressor system, since important factors such as location can be taken into account. It can, however, still prove attractive to retrofit a heat recovery system

Initially, it is important to establish if the current demand for compressed air is a TRUE demand.

Major savings in compressed air demand can be achieved through a range of good practice measures, many of which are low-cost and simple to carry out (see Good Practice Guide 126 *Compressing Air Costs*).

If a heat recovery system is designed on the basis of original compressor load, i.e. before any energy saving changes are undertaken, it will not produce the expected savings if compressor output is reduced as there will not be as much waste heat available.

Consult the air compressor manufacturer to determine the actual heat available at part load: in many cases the heat available will not fall proportionally to the air demand. Simply assuming that the heat available is directly proportional to the air demand is likely to underestimate the potential heat available.

Where there are multiple air compressors, take the rotation of the plant sequencing into account when designing the heat recovery system. For example, if there are three machines and the lead machine is changing, unless heat is recovered from all three machines, the amount of heat that can be recovered will be reduced.

2.1 Estimating the Available Heat from a Compressor Installation

Once the actual mean power consumption of the compressors is known, the potential heat recovery should be up to 90% of this value (depending on installation losses through, for example, insufficient pipe lagging or leakage). The actual heat benefit from the system will depend on the installation chosen and typical loading on the compressor.

For an existing installation, take readings of the time spent on and off load by the machines under consideration and calculate the benefits on the average loaded condition. Built-in instrumentation, such as hours run meters, will assist in establishing true load factors. Full load heat available from the compressor can be taken from the manufacturer's literature.

Where the economic viability is critical, carry out site measurements of cooling air volume flow, inlet and outlet conditions at a typical load condition to determine accurately the heat available, as shown in the following example.

Example: Determining the heat available from a 450 l/s compressor using the specific heat method

For a 450 l/s (953 cfm) compressor with a nominal motor power of 160 kW compressor, from data in Table 1:

Measured cooling air flow at 10°C = 4,160 l/s = 5.14 kg/s (based on 0.81 m³/kg air density)

Measured inlet conditions at 10°C = 20 kJ/kg
(from steam tables)

Measured outlet conditions at 38°C = 48 kJ/kg
(from steam tables)

Therefore, heat available from compressor = (48 - 20) x 5.14 = 144 kW

If there is extensive ductwork, e.g. above 10 m between the compressor house and the demand for the heat, particularly where it runs outside the building, the ductwork heat losses must be taken into account in any calculations. Data on heat losses from ductwork are given in Volume C, Page C3-20, of the CIBSE Guide Volume C: *Reference Data*, available from CIBSE, 222 Balham High Road, London SW12 9BS.

HEAT RECOVERY OPTIONS FROM

OIL-INJECTED SCREW COMPRESSORS

- Injected oil is used to cool the air as it is being compressed and seal the compressor elements.
- Over 75% of the heat of compression can be removed in the oil cooler, the balance by the after-cooler and radiation losses.

Air-cooled

- Smaller units - recovering hot air is usually straightforward providing it is canopied or in its own compressor room (see Open System, Section 3.2.1).
- Larger units - usually canopied, allowing hot air recovery by connecting ductwork for supplying space heating etc.
- Hot water - can be produced on some units by adding an oil-to-water heat exchanger on the oil cooler.

Water-cooled

- Both the oil cooler and after-cooler are cooled by an external water circuit. A heat exchanger can be used to heat hot water or boiler feed water, or to fulfil process demands.

OIL-FREE SCREW COMPRESSOR

Air-cooled

- Normally packaged in acoustic canopies, the heat from intercoolers, oil cooler and after-coolers can be recovered via ductwork at the package cooling air discharge.

Water-cooled

- A heat exchanger can be used in the cooling circuit to heat hot water or boiler feed water, or to fulfil process demands.
- Special models are available with double pass inter- and after-coolers, which can produce hot water at up to 95°C.
- Some models can be supplied with an integral desiccant dryer which uses the waste heat for desiccant regeneration.

DIFFERENT TYPES OF AIR COMPRESSORS

RECIPROCATING COMPRESSORS

Air-cooled

- Small units - hot air recovery normally achieved via louvres in the compressor room wall (see Open Sytem, Section 3.2.1) to space heating.
- Large units with integral coolers - the cooling matrix can be connected to ductwork allowing hot air recovery for space heating, etc.
- Large units with separate coolers - it may be more difficult to collect all waste heat. However, ducting on either the inter-cooler or after-cooler would enable 50% of the available heat to be recovered.

Water-cooled

- Normally the inter-cooler, after-cooler and cylinder jackets are cooled by an external circuit and a heat exchanger can be used to heat hot water, boiler feed water or process demands.

CENTRIFUGAL COMPRESSORS

- Nearly always water-cooled with two, three or four stages of compression. A heat exchanger can be used to heat hot water or boiler feed water, or to fulfil process demands.
- The efficiency and control range of these units can be compromised by deviating from the unit's designed cooling water temperatures - consult the manufacturer before introducing heat recovery.

ENGINE-DRIVEN AIR COMPRESSORS

- Very large energy savings can be made by driving compressors with engines and using the rejected heat from the engine and compressor.
- Future developments could include taking bleed air from the compression stages of a gas turbine which is used to drive a combined heat and power (CHP) system. However, this will be more applicable in larger industrial installations. (This technique is already often seen in the offshore oil and gas industry to provide oil-free air at 7 barg for the platform instrument and works air systems).

3. POTENTIAL USES FOR HEAT (THE HEAT SINK)

Stage 2 - IDENTIFY THE HEAT SINK

- Roughly how much heat is required?
- When is the heat needed?
- Where is the heat needed?

Before deciding to install a heat recovery system, it is essential to identify the possible uses for the recovered heat by considering all the options throughout the feasibility study. The possibility of using the heat for two different functions should also be borne in mind to maximise energy savings.

Recovery systems are generally able to provide hot air at up to 80°C or hot water at up to 95°C. This presents a range of uses, many of which are in the building services, e.g. space heating and domestic hot water. Each application will be different. The case studies in Section 6 show a variety of practical examples and demonstrate the real savings that have been achieved in industry.

TRUE heat demands must be found, i.e. those that can actually be reduced by using the recovered heat. For example, there is little point in ducting hot air to a space which is currently unheated or to one that is already overheated because of a lack of space heating controls. In the latter case, however, heat recovery may prove worthwhile if the space heating controls are upgraded. Always carry out simple energy saving measures before investing heavily in heat recovery projects: typical measures for industrial buildings are presented in Energy Consumption Guide 18¹.

3.1 Estimating the Demand for Heat

Before designing a heat recovery system, the real demand for heat must be estimated as closely as possible. In simple systems, there may be a demand for all the available heat, but in more sophisticated systems with, for example, summer heat dumping and/or automatic controls, the heat demand will be less easy to estimate. Night operation of the compressors also needs careful consideration, as the machine may be on a very low load and the building may be unoccupied during these hours, although heat recovered at night can provide a useful contribution towards the space heating demand for the next day.

Estimate the hours per year where waste heat can be used. It may not be possible to utilise the waste heat at all times. For example, in a space heating application the heat will only be useful in the winter months. In such cases, a simple estimate can be made based on the times set on the heating controls and the length of the heating season, taking average boiler loading into account. Closer estimates can be made using degree day calculations, as shown in section B18 of the CIBSE Guide Volume B².

Hot water consumption can also be estimated using information in the CIBSE Guide Volume B. A typical figure of four litres per person per day is appropriate in most factories. Estimates of savings on hot water systems should also take account of heat exchanger efficiency if an indirect hot water system is used. As a guide, typical space heating and hot water energy consumption for industrial buildings is given in Energy Consumption Guide 18.

¹ Energy Consumption Guide 18, *Energy Efficiency in Industrial Buildings and Sites*, is available from the BRECSU Enquiries Bureau. For contact details, please see the back cover.

² CIBSE Guide Volume B: *Installation and Equipment Data*, available from CIBSE, 222 Balham High Road, London SW12 9BS.

3.2 Recovering Heat for Space Heating

Air heat recovery systems can range from a simple direct supply into a factory area through to systems with automatic controls and extensive ductwork. The approach taken is likely to depend on the size of machine involved and the particular requirements for space heating in the individual building. The simple approach is just to ‘dump’ heat into the factory space and let the space heating controls respond to this input. In more controlled industrial environments, such as IT assembly plants, internal conditions are more sensitive and this simplistic approach could lead to overheating. In these more thermally-sensitive areas, it may be necessary to install a fully-integrated control system to avoid overheating and maximise savings by preventing operation of the space heating when there is ample ‘free’ heat available.

Recovering hot air is most effective where the space heating system is based on warm air, but is also applicable with radiant panels or conventional radiators. The directly heated air stream can also be used for space heating via air curtains over loading bays and large factory doorways. Air heat recovery is not recommended where the existing space heating system is based on high temperature radiant heaters. Radiant tube and plaque heaters are an effective and efficient means of heating large industrial buildings due to the high air change rates that are involved. These radiant systems heat the occupants and building fabric but they do not heat the air like a convective warm air system does. In these cases, supplying warm air from a heat recovery system will heat the air in the space unnecessarily and the anticipated energy savings will not be achieved.

Most space heating applications will require some form of damper arrangement to allow hot air to be dumped to atmosphere in the summer. With manual dampers, care must be taken to ensure that the dampers are not left on the summer setting in winter or vice versa. Installing automatic dampers, controlled by internal space temperature and external air temperature, can avoid this and savings are likely to be greater despite incurring some additional capital costs.

Rule of thumb: When operating at full load, each kW of compressor power can heat roughly 5 - 10 m² of a typical factory. In a new build situation, the compressor should be able to heat roughly twice this (10 - 20 m²/kW) due to better levels of insulation and air-tightness.

NB This is only a rough indication of the potential heat recovery; actual values will depend on the particular type of building, its insulation and air-tightness along with the hours run and loading of the compressor.

3.2.1 Hot Air Recovery - Open System

The most common approach to hot air recovery is to supply the air stream straight into the factory to contribute to space heating. A typical small rotary air-cooled compressor with heat recovery is shown in Fig 4. Some method of dumping the hot air to atmosphere must be provided for warm weather conditions.

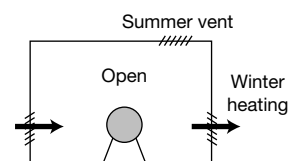

Smaller reciprocating units can also be installed so that the cooling matrix, which usually contains both coolers, is placed against an outside wall. This allows the fan to draw the coolest possible air through ventilation louvres in the wall. The air flow leaving the fan can then be directed into the building to supplement normal space heating with waste heat from the compressor during cold spells.

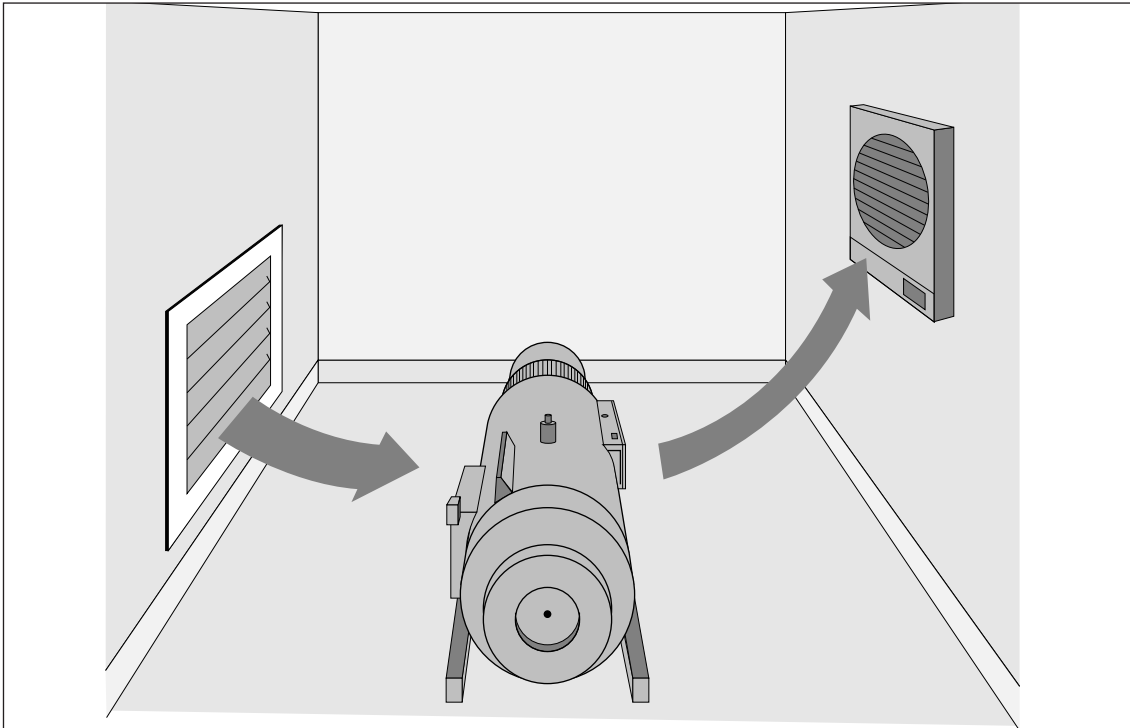
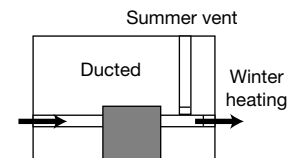

Fig 4 Typical small air-cooled compressor with direct heat recovery

3.2.2 Hot Air Recovery - Ducted System

Where the compressor is packaged in an acoustic canopy, heat recovery can best be achieved using ductwork as shown in Fig 5. The air to be compressed, and that used for cooling, is normally drawn in at one end of the packaged compressor, either by a shaft or electric motor-driven fan, and exhausted through the opposite end of the canopy. A duct can be fitted to the exhaust air stream, to distribute hot air to its point of use. Avoid restricting the cooling air flow as this will reduce compressor efficiency, and use secondary fans in the downstream ducting, if necessary. Manufacturers provide guidelines for the cooling flow requirements of each compressor, including data on the maximum lengths of ducting allowed without additional fans. Arrange ducting to allow hot air to be dumped during warmer periods when it is not required for space heating.



The factory heating system must be fitted with space heating controls or hot water controls (as appropriate) to respond to the input of heat, to prevent overheating which would reduce the actual savings achieved.

In most cases, compressor noise and any reduction in the freshness of recovered air will not be noticed in a factory environment. However, where the working environment is more sensitive, e.g. IT assembly areas, then some sound attenuation and filtering may need to be considered.

Ductwork may also be required to avoid formation of hot and cold spots which can occur where hot air is simply 'dumped' into a factory. Arrange ducting to allow hot air to be dumped during warmer periods when it is not required for space heating. Where long lengths of ductwork are

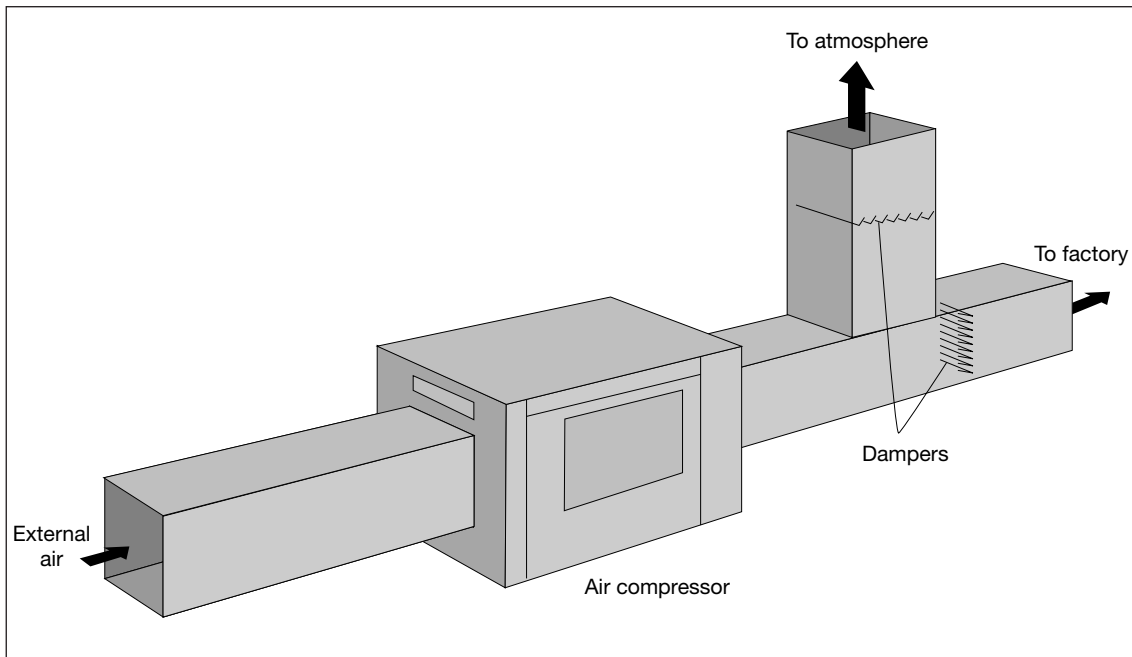

Fig 5 Typical large air-cooled compressor with direct heat recovery

necessary, an auxiliary fan will be required to overcome the duct pressure drop. Always consult compressor manufacturers about fan requirements. Auxiliary fans incur running costs which need to be taken into account in the economic calculations.

Fire regulations are paramount and system designers should always consider whether fire dampers are required for ductwork.

Oil injected rotary screw compressors have a safety valve fitted on the oil reclaimer vessel. If the delivered air pressure exceeds the safety limits for any reason this valve will lift and a mixture of compressed air and oil vapour will be emitted within the acoustic canopy. If the machine is used for air heat recovery, the air from the safety valve which has been contaminated with oil vapour could be transmitted through the ducting to the area where the waste heat is being employed.

The safety valve should be piped to the outside of the canopy to prevent this problem.

A common problem of heat recovery systems is the lack of a clear indicator that heat is actually being recovered. Installations frequently remain on their winter setting all year round, recovering heat during summer resulting in overheating. Equally, systems are often found dumping heat on summer settings during winter. Installing a clear indicator on the compressor control panel which shows the temperature of the heat recovered will help to avoid this.

3.3 Recovering Heat for Hot Water

Heat is normally recovered from water-cooled compressors as hot water up to 95°C. Using a heat exchanger and an auxiliary pump, it is relatively straightforward to utilise this to generate domestic hot water at, say, 60°C for hand washing, etc. Domestic hot water, however, usually presents much smaller loads than space heating and the recovered heat available may not be fully utilised. Consider other possible uses or take into account this lower utilisation of heat during the feasibility study.

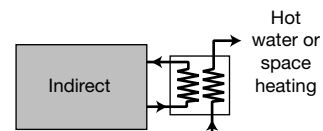

The demand for hot water is a fairly constant throughout the year, although the daily demand varies considerably, requiring little through the morning and a large peak at lunch time for instance. Attempting to utilise, say, 50 kW of recovered heat to meet a load that fluctuates from

5 kW to 100 kW can prove difficult. Installing an insulated hot water storage vessel can help to smooth out the peaks and provide a constant demand, even though this will add to the capital cost of the project. The vessel will also require a control system to ensure that the hot water is stored at the correct temperature: storing water below 55°C is not recommended due to the possibility of legionella and storing it above 65°C will unduly increase standing losses.

Rule of thumb: When operating at full load, heat recovery from a 60 kW compressor should heat enough hot water to supply roughly 100 people in a typical factory.

NB This is only a rough indication of the potential heat recovery: actual values will depend on the particular type of factory and its hot water heating system, together with the hours run and loading of the compressor.

3.3.1 Hot Water Recovery - Using a Heat Exchanger

A plate heat exchanger can be used to recover heat from water-cooled machines, creating a closed circuit to avoid contamination and fouling of the compressor cooling system. A simple approach to this is shown in Fig 6. This relatively simple approach can also be used to supply space heating via a radiator or unit heater circuit. The capital cost and efficiency of the heat exchanger must to be taken into account when assessing the economic viability.

A motorised valve and thermostat should be included to control the temperature of the water and also prevent heat being fed back from any thermal store into the compressor, as this could overheat it and may reduce its efficiency.

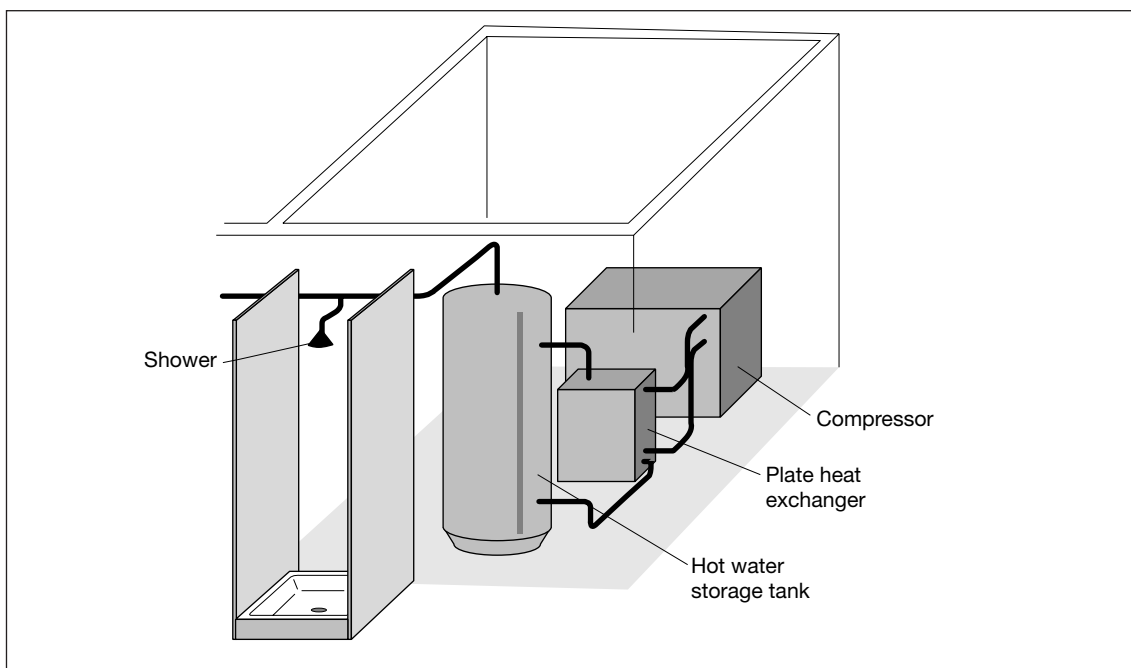

Fig 6 Using a heat exchanger to recover hot water

3.3.2 Hot Water Recovery - Oil-to-Water Heat Exchanger

A more sophisticated hot water recovery system is shown in Fig 7. This system allows control of the cooling towers if the heat cannot be recovered. In these cases, a plate or shell and tube heat exchanger can be placed in the hot water return line, creating a primary cooling circuit with a secondary heat recovery circuit. If the heat recovery circuit cannot absorb all the heat, the cooling tower must be controlled to meet the shortfall.

Some manufacturers can supply a heat exchanger integral to the compressor to provide hot water from air-cooled packages. With air-cooled rotary screw compressors an energy recovery unit can be installed to provide hot water from the oil cooler. This unit is thermostatically-controlled to ensure that the correct temperature parameters within the compressor are met before heat

recovery is allowed. With hot water heat recovery systems, the heat can be used for increasing the temperature of boiler feed water, domestic hot water, showers, central heating systems and process water.

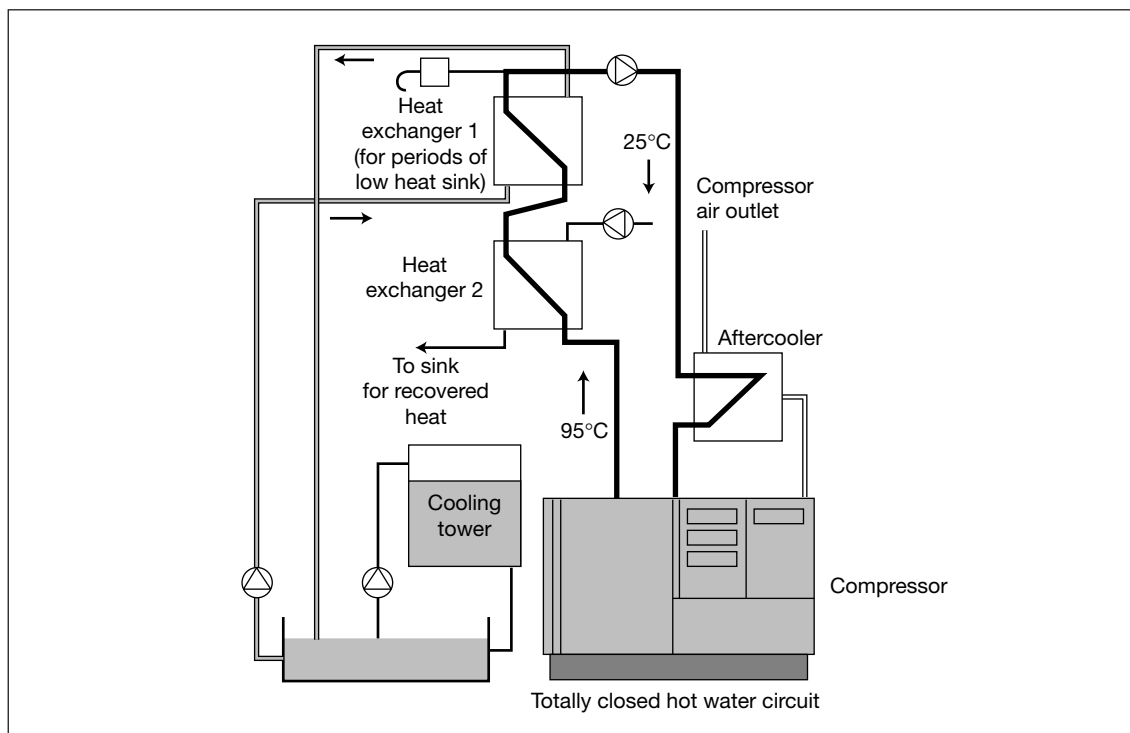

Fig 7 A sophisticated oil-to-water heat recovery system

3.4 Recovering Heat for Boiler Pre-heating

It is possible to install heat recovery systems to pre-heat either combustion air or boiler feed water being used in large boilers.

3.4.1 Pre-heating Combustion Air

Gas boilers need roughly 10 - 16 m³ of combustion air for every 1 m³ of gas burnt and oil boilers 13 - 16 m³ of combustion air for every kg of oil burnt. Both natural gas and HFO-fired boilers have a minimum combustion requirement (based on 60°C air) of roughly 1,450 m³/hour per MW of boiler steam output, making this form of heat recovery more applicable in larger boiler installations.

Boilers without oxygen trim control may experience some variations in excess air level depending on the air temperature at the intake. Consult the burner manufacturer before modifying the system to ensure that the equipment is suitable for the elevated combustion air temperatures, although temperatures of up to 60°C are unlikely to present a problem. Pre-heating boiler combustion air in this way can often be a highly economic way of utilising the recovered heat.

Rule of thumb: When operating at full load, recovering the cooling air from a 20 kW compressor should provide enough pre-heated air to supply the combustion requirements of a 1 MW boiler.

NB This is only a rough indication of the potential heat recovery: actual values will depend on the particular type of boiler and the fuel being used, together with the typical hours run and loading of the compressor.

Air heat recovery systems can supply hot air directly to the boiler forced draft combustion air intake. The preferred approach, as shown in Fig 8, is very simple, with the boiler air damper directly controlling the amount of warm air recovered, while still ensuring that sufficient air is available for combustion. The capital cost of such a scheme is relatively low and energy savings are likely to be high, resulting in a short payback period.

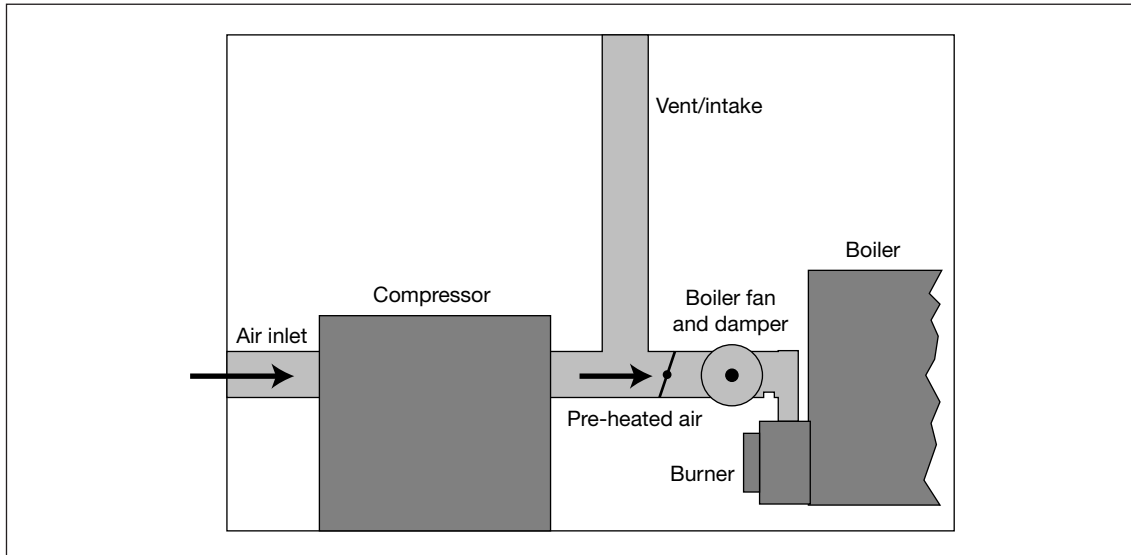
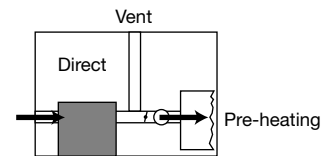

Fig 8 Direct forced draft boiler intake of hot air

An alternative approach is shown in Fig 9. While this appears to be simpler, in some cases it could result in overheating of the boiler house at low boiler loads or when the boiler is off. This approach may therefore need a more sophisticated automatic control system, using air dampers interlocked with the boiler load, to enable heat dumping when the boiler is at low load or off.

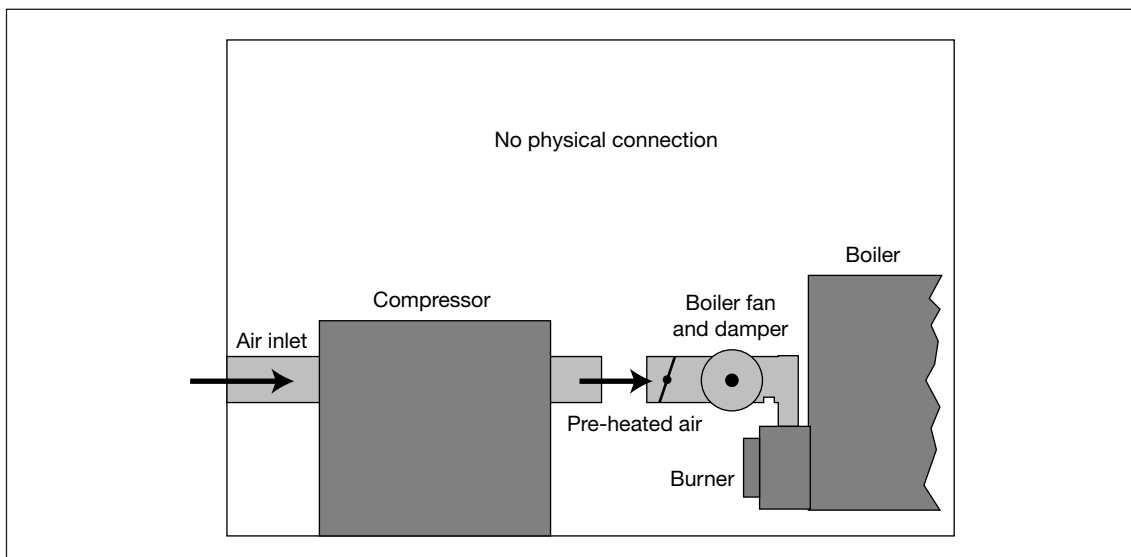
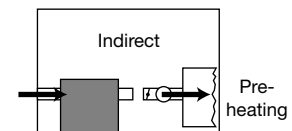

Fig 9 Indirect boiler intake of hot air

3.4.2 Boiler Make-up Water Pre-heating

All steam boilers require make-up water, and energy savings can be achieved by pre-heating this water en route from the water treatment unit to the hot well or deaerator. Heat recovery from a water-cooled compressor can be achieved using a heat exchanger (double pipe, shell and tube,

or gasketed plate heat exchanger), or in some cases with a heating coil within a buffer storage vessel. These systems can usually be kept relatively simple, as there is little need to control temperature. When the boiler load is low, there will only be a small requirement for feed water and less heat will be recovered: take these low load situations into account when estimating the likely savings. This method is only applicable where the hot well temperature is less than 80°C.

Rule of thumb: When operating at full load, recovering the cooling air from a 50 kW compressor should provide enough pre-heated make-up water to supply the requirements of a 1 MW boiler, assuming a 60% condensate return.

NB This only provides a rough indication of the potential heat recovery: actual values will depend on the particular type of boiler and the fuel being used, together with the typical hours run and loading of the compressor.

3.5 Recovering Heat to Supply Process Loads

Waste heat from air compressors can be used to supply particular process loads. The warm air stream from air-cooled compressors is particularly suited to drying processes. Heat available from water-cooled compressors is most suitable for washing/cleaning processes.

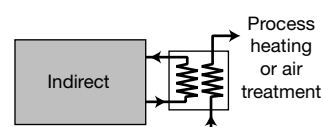

3.6 Compressed Air Treatment

Some manufacturers of oil-free screw compressors and desiccant dryer treatment systems use the waste heat of compression to reduce the cost of compressed air drying. Certain configurations of desiccant dryer require heated air to regenerate the drying medium, and equipment is available which uses the heat from the compressor for this purpose.

This method of using waste heat can cut treatment costs dramatically when a pressure dewpoint in the range of -20°C to -40°C is required.

Rule of thumb: Positive displacement compressors should be capable of supplying sufficient heat to regenerate the drying medium in a desiccant dryer of at least the same capacity. Centrifugal compressors may require a supplementary heat supply due to the lower discharge temperatures.

NB This only provides a rough indication of the potential heat recovery: actual values will depend on the particular type of dryer together with the typical hours run and loading of the compressor.

4. MATCHING THE HEAT SOURCE AND SINK

Stage 3 - IS THERE A MATCH BETWEEN HEAT SOURCE AND SINK?

- Useful quantities of heat?
- Similar times?
- Similar locations?

Matching the heat source and the heat sink is an essential part of the feasibility process, which involves assessing:

- the quantity of heat available versus that required;
- the temperature of the heat available and that required;
- the times at which the heat is available and required;
- the distance between the heat source and the heat sink.

This matching is the key to successful and economic heat recovery. For example, the average daily hot water demand may appear similar to the heat recovered, but it may actually be required in two large peaks rather than as a constant demand throughout the day, making it more difficult to recover the heat usefully. Fig 11 illustrates the matching process. The better the utilisation of the available heat, the better the economic payback.

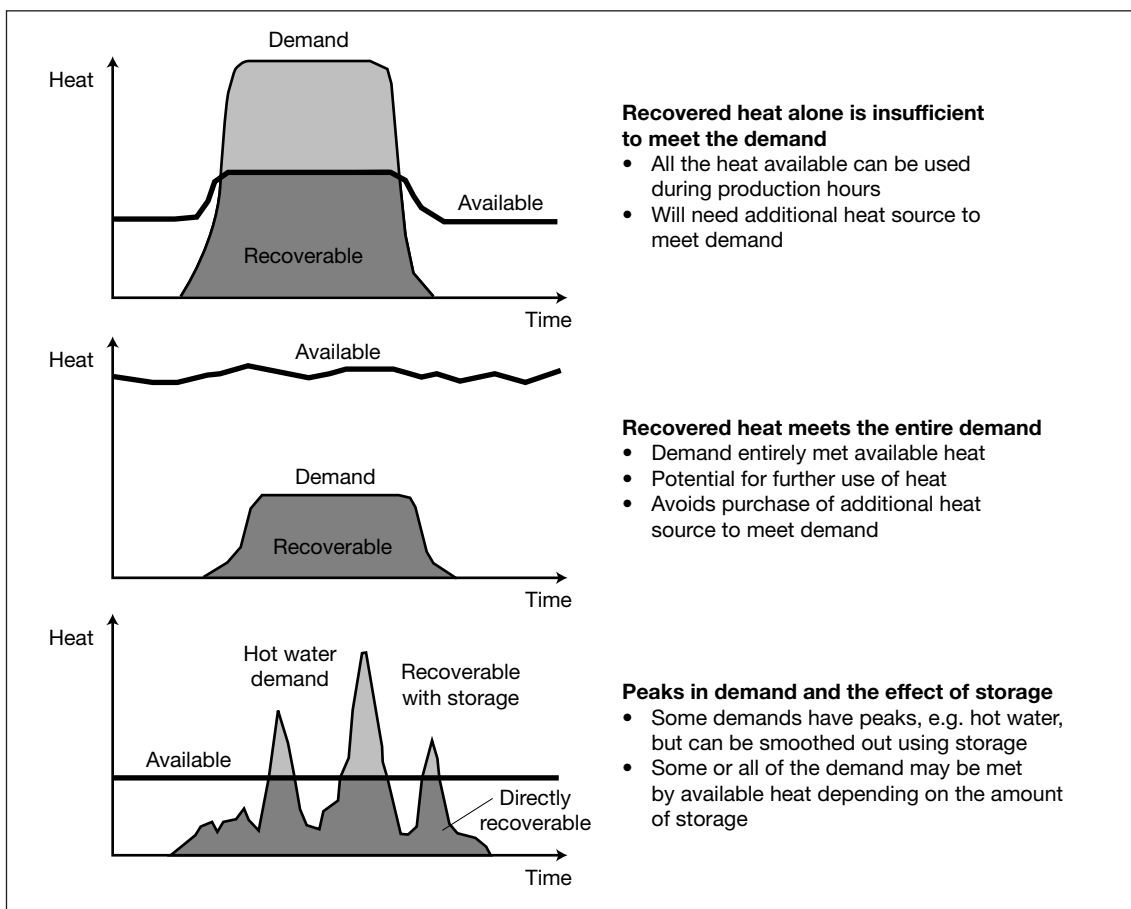

Fig 10 Matching heat demand and heat availability

4.1 Heat Quantities and Temperatures

The quantity and temperature of the heat available and the level of heat demand must be estimated to ensure that:

- the compressor is sufficiently cooled to the requirements laid down by the manufacturer, as any reduction in cooling can reduce its efficiency;
- a large proportion of the heat available can be absorbed successfully by the heat sink without presenting problems;
- the temperature of the heated medium is suitable for the duty: too low a temperature may result in a deterioration of the service, e.g. domestic hot water, although pre-heating can still be worthwhile, whereas too high a temperature may result in overheating.

In larger factories, or where there are wide comfort tolerances, it should be possible to use all the available heat by simply 'dumping' it to provide space heating. In smaller factories, or where close comfort tolerances are required, the use of heat requires more careful consideration to prevent overheating, etc., particularly where available heat constitutes a large proportion of total demand.

Where it is not possible to utilise all the available heat, some mechanism for heat dumping will be needed, e.g. ductwork to dump heat in the summer when space heating is not required. In such cases, dampers will be needed to set summer and winter conditions. If manual dampers are fitted, care must be taken to ensure that the cooling air supply to the compressor is never cut off by closing both dampers. In some larger installations an automatic control system may be justified, which operates motorised air dampers during certain conditions to avoid overheating, i.e. above a certain internal space temperature. Automatic dampers need to be interlocked so that one air path is always open.

4.2 Times

Once the quantities and temperature of the heat are roughly matched, consideration must be given to when the heat is available and when it is required.

- Is the heat always available or are there long periods when the compressor is not operating? For example, the compressor may be off at night when the building is unoccupied, although some heat could be supplied to the factory ready for the next day.
- Is the heat required all year round? For example, space heating would typically be required only during the heating season. The higher the percentage of the year that the recovered heat will be used, the better the economic case for the system.
- What percentage of the available heat would be used at any one time? For example, domestic hot water is a year-round demand but is highly intermittent throughout the day, resulting in long periods where only a little heat is required.

Peaks in heat demand can be met by installing some form of heat storage. For example, a storage calorifier can be installed to meet peaks in hot water demand. Hot air can only be 'stored' in the sense of effectively pre-heating a building overnight to reduce the heating load on the following working day

4.3 Location

The closer the heat source and sink, the lower the overall capital cost and hence the shorter the payback period.

It is impractical to transport recovered heat over long distances as the capital cost of the ductwork or pipework is usually prohibitive. Pipework is cheaper than ductwork and it is therefore possible to site a water-cooled compressor, and the equipment that uses the heat from

it, further apart than would be possible with air-cooled plant. Air-cooled systems situated in a compressor house next to the factory are ideal.

Distant plant rooms will require long lengths of ductwork, insulation and probably an auxiliary fan. Some heat may be lost from ductwork, even when insulated, and this needs to be taken into account during feasibility studies. External ductwork should always be insulated to minimise heating losses.

5. ESTIMATING THE ECONOMICS

Stage 4 - ESTIMATE THE ECONOMICS

- Capital Costs?
- Running Costs?
- Payback Period?

For small machines and/or very simple heat recovery systems with a low capital cost, a rough estimate of the economic return should be sufficient to justify investment. For larger machines and/or where there is a high capital cost, a fuller appraisal should be carried out.

Tables 2 and 3 provide a simple worksheet to help estimate the simple payback period. The approach shown is generalised; details of the particular plant and the site need to be included to make this more specific.

5.1 Estimating the Payback Period

Once the heat source and sink have been quantified and matched, estimate the simple payback period for the project using the capital costs and the running costs. Tables 2 and 3 show the basic steps involved when calculating the payback of a heat recovery installation. For guidance, simple worked examples are also covered in the tables, based on typical cases.

5.1.1 Capital Costs

Capital costs are highly dependent on the particular site and the machines involved. It is important to take into account ALL the capital costs which might include:

- ductwork or pipework;
- insulation;
- controls;
- dampers or valves;
- auxiliary fans or pumps;
- modifications to oil reclaimer safety valve;
- water storage vessels.

Where the purchase of boiler plant capacity can be reduced or avoided, only the marginal capital cost need be taken into account, i.e. the capital cost of the heat recovery system less the cost saving due to reduced boiler capacity. Often, a heat recovery system will be less than the capital cost of new boiler plant.

5.1.2 Running Costs

Use the gross cost of the fuel saved when calculating savings. This is the actual unit cost of the heat saved, e.g. if recovered heat is displacing that from a gas-fired boiler, with gas at 0.8 p/kWh and a boiler efficiency of 0.75, energy savings will be 1.07 p/kWh displaced.

Take into account the additional costs of any auxiliary equipment (e.g. fans or pumps), although this is usually small. For example:

$$\text{Auxiliary fan running costs} = \frac{(\text{fan kW}) \times (\text{hours run/year}) \times (\text{electricity costs p/kWh}) \times 100}{\text{motor efficiency}}$$

The running costs of a 5 kW fan with a motor efficiency of 85%, running for 4,500 hours per year would be roughly £1,200/year.

5.2 Worked Examples of Payback Calculation

Example 1 - three air-cooled 360 l/s (750 cfm) 132 kW compressors (Fig 11)

- Monitoring the hours-run and hours-loaded meters revealed typical loading for the site is for one compressor to meet the base load, the second to be loaded on average for 30% and the third to act as a standby. The compressors are rotated in duty to equalise running time.
- A nearby large assembly area requires space heating for half the year, currently heated by the site's gas-fired boiler. Boiler efficiency is estimated at 75% and the current cost for gas is 0.8 p/kWh. The assembly area is heated for 10 hours per day for five days of the week, and 5 hours on Saturdays. The current cost for electricity is 4.5 p/kWh.
- A quote from the compressor supplier to install the necessary ductwork, 5 kW booster fan, lagging and hot weather bypass is £3,500.

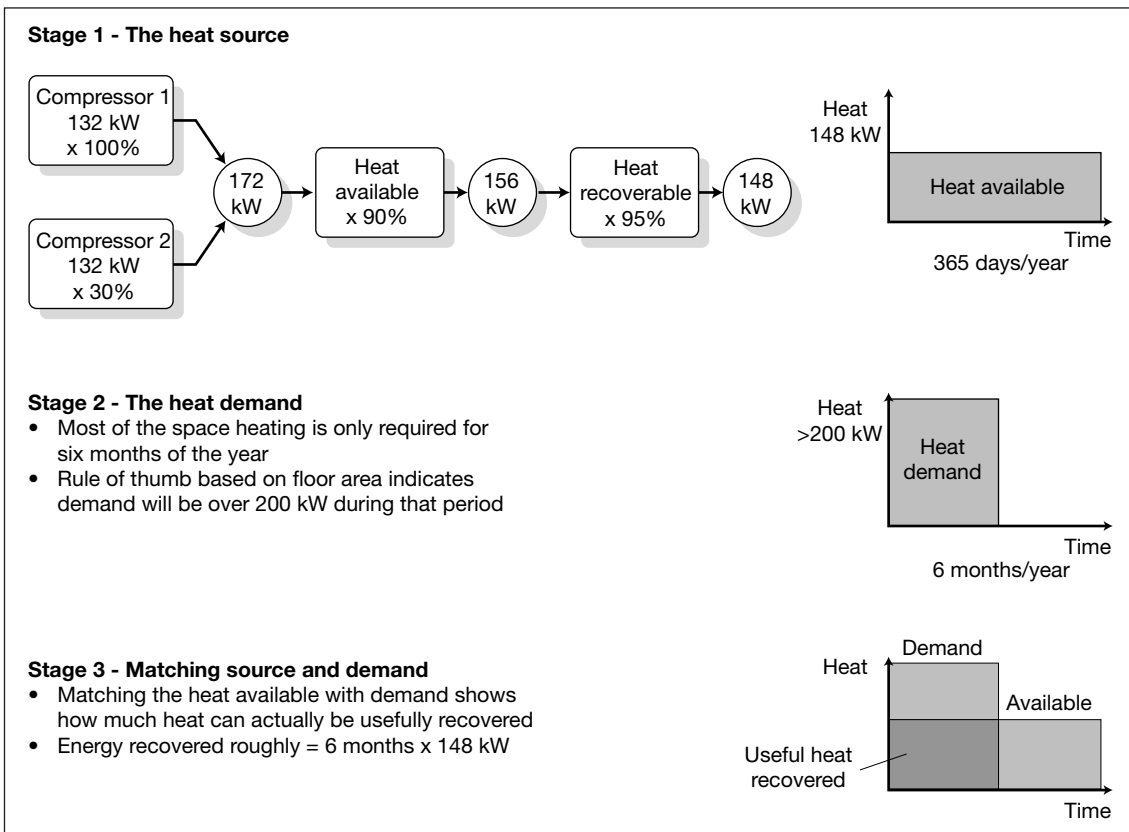

Fig 11 Example of matching source and demand

Table 2 Worked Example 1

		Simple Worked Example:
A) Full load heat available from each compressor kW	132 kW x 90% = 120 kW
B) Compressor load factor %	100% + 30% = 130%
C) Total waste heat available (A x B/100) kW	120 kW x 130% = 156 kW
D) Percentage of heat available that can be used %	95% (5% losses estimated)
E) Average heat that can be utilised (C x D/100) kW	156kW x 95% = 148 kW
F) Hours per year where waste heat can be used h/yr	(50 h + 5 h) x 24 wk/yr = 1,320 h/yr
G) Annual energy saved (E x F) kWh/yr	148 kW x 1,320 h/yr = 195,360 kWh/yr
H) Gross cost of fuel saved £/kWh	£0.008/kWh / 75% = £0.011/kWh
I) Annual fuel cost saving (G x H/100) £/yr	195,360 kWh/yr x £0.011/kWh = £2,150/yr
J) Cost of running any auxiliary equipment £/yr	5kW x 1,320h/yr x £0.045/kWh = £300/yr
K) Overall cost savings (I - J) £/yr	£2,150/yr - £300/yr = £1,850/yr
L) Capital cost £	£3,500
M) Simple payback (L/K) yrs	£3,500 / £1,850 = 1.9 years

Example 2 - Two air-cooled 158 l/s (335 cfm) 55 kW compressors

- One compressor meets the base load, while the second is part loaded to meet the demand.
- There is nearby use for water at 60 - 70°C. It is assumed that an energy recovery system fitted to the lead compressor would heat most of the water, with the existing gas-fired boiler making up any shortfall during peak demands. Boiler efficiency is estimated at 75% and the current cost for gas is 0.8 p/kWh. The site operates for two shifts for 105 hours/week, 48 weeks/year. The current cost for electricity is 4.5 p/kWh.
- A quote from the compressor supplier to supply the energy recovery system is £4,000. With the compressor fully loaded, the system is rated to heat 15 l/min of water by 50°C (52 kW). However, 20% losses are estimated for the system in transferring the heat from the compressor to the point of use.

Table 3 Worked Example 2

		Simple Worked Example:
A) Full load heat available from each compressor kW	52 kW
B) Compressor part load factor %	100%
C) Total waste heat available (A x B/100) kW	52 kW x 100% = 52 kW
D) Percentage of heat available that can be used %	80% (20% losses estimated)
E) Average heat that can be utilised (C x D/100) kW	52 kW x 80% = 42 kW
F) Hours per year where waste heat can be used h/yr	(105 h) x 48 wk/yr = 5,040 h/yr
G) Annual energy saved (E x F) kWh/yr	42 kW x 5,040 h/yr = 211,680 kWh/yr
H) Gross cost of fuel saved £/kWh	0.8p/kWh / 75% = £0.011/kWh
I) Annual fuel cost saving (G x H/100) £/yr	211,680 kWh/yr x £0.011/kWh = £2,330 /yr
J) Cost of running any auxiliary equipment £/yr	–
K) Overall cost savings (I - J) £/yr	£2,330/yr
L) Capital cost £	£4,000
M) Simple payback (L/K) yrs	£4,000 / £2,330 = 1.7 years

6. CASE STUDIES OF PRACTICAL HEAT RECOVERY INSTALLATIONS

The following case studies show companies that have benefited from compressed air waste heat recovery systems.

Ref	Site	Use of heat
1	David Brown Radicon plc, Sunderland	Space heating
2	GPT Ltd, Liverpool	Space & water heating
3	Caradon MK Electric Ltd, St Asaph	Water heating
4	SGB Youngman, Slinfold	Water heating
5	Cookson Matthey Ceramics & Minerals Ltd, Tyne & Wear	Space & water heating
6	Short Brothers plc, Belfast	Space heating
7	Baxter Healthcare Ltd, Thetford	Process water
8	GSPK Circuits Ltd, Knaresborough	Space heating

6.1 Case History 1: David Brown Radicon plc, Sunderland

David Brown Radicon plc manufactures gear drive units for industrial uses and employs 213 personnel at its Sunderland site. In 1993 the company decided to increase the compressed air capacity at the plant and two 40 kW air-cooled air compressors were installed within the factory. The decision to use air cooling was made for economic reasons and in consideration of the possible health risks of open cooling tower installations.

To provide energy savings, a galvanised ducting system was installed for both machines to direct waste heat into the factory during the winter months, with louvres to vent the air outside in summer months. The energy recovery system accounted for approximately 5% of the total installed cost.

The energy savings produced by this simple ducting system have resulted in a payback of less than a year.

6.2 Case History 2: GPT Ltd, Liverpool

GPT Ltd's factory in Liverpool, which manufactures digital telephone exchange systems, saves up to £15,000 every year through its two heat recovery systems.

In 1987, GPT installed three 75 kW rotary air compressors at its plant to provide energy savings. The waste heat has been further utilised by GPT to heat other parts of the site. The energy savings made each year are dependent on climatic conditions.

The cooling systems of the two water-cooled compressors, which operate at 76°C, were joined together and directed through a common heat exchanger. A lagged piping system was installed to connect this to the manufacturing area to heat domestic water for both the offices and the canteen.

The surplus heat from the third, air-cooled compressor, was directed to the adjacent sprinkler room which has to be kept at a constant 50°C. This compressor, which runs under part load, has proved capable of fully meeting the heating demand without recourse to the gas space heaters, which are now used on a standby basis.

6.3 Case History 3: Caradon MK Electric Ltd, St Asaph

Caradon MK Electric Ltd is a division of the Caradon Group, manufacturing PVC cable management systems. It currently employs some 250 people at its North Wales factory. A single 90 kW compressor provides compressed air for the site. Prior to a recent upgrade of the compressed air system, hot water for the site was heated by a feed from the gas-fired boilers in the winter and a three-phase immersion heater in the summer. This hot water system fed the factory toilets and the industrial canteen.

The upgrade of the compressors in 1993 involved the purchase of a new machine, using the old duty compressor as a standby. This new compressor was purchased with an optional internal oil-to-water plate heat exchanger. Hot water from the heat exchanger is pumped to the existing calorifier at a temperature of 80°C. This system used the heating coil, previously supplied from the boilers. The new pipework needed to be well lagged since the compressor station was some 100 metres from the hot water supply. Since there was spare capacity in the new system, particularly during periods of low demand, compressor cooling air is ducted into the factory, as required, when the calorifier has reached a set temperature.

The compressor is in operation throughout production hours, therefore hot water is always available. The savings obtained from the new system paid for the heat recovery installation within the first year.

6.4 Case History 4: SGB Youngman, Slinfold

SGB Youngman, a subsidiary of Mowlem plc, manufactures ladders and access equipment at its West Sussex site. In 1989 the company was expanding its production facilities, and the ageing reciprocating air compressor was undersized for the required duty. Hot water for the site was provided by the wood burning boiler in the winter, and a 9 kW immersion heater during the summer. However, a new canteen was being planned, resulting in a considerable increase in the demand for hot water. For the summer months, an alternative heat supply for the water was required.

The company decided to purchase a 68 kW oil-injected rotary screw compressor, sized to meet the future air requirements of the site. For an additional 25% cost, the compressor was specified with an internal oil-to-water heat exchanger, which would heat the site water supply through a calorifier. Following the success of this installation, the hot water system can now easily cope with the added demand of the canteen.

This heat recovery system, although only used during the warmer months, paid for itself within two years. As a result of their use of this system, the company won an Electricity Council PEP award.

6.5 Case History 5: Cookson Matthey Ceramics & Minerals Ltd, Tyne & Wear

Cookson Matthey Ceramics & Minerals Ltd is a joint venture company between Cookson Group plc and Johnson Matthey plc, producing micronised zircon and antimony oxide at its Howdon site. The company has pursued a policy of energy conservation for many years. In 1989, a 95 kW air compressor was installed, together with an energy saving pack (ESP) that takes the waste heat from compressor oil cooling, via a heat exchanger. This supplies central heating and hot water at between 70°C and 80°C to the 800 m², three-storey research building located some 30 m from the compressor house.

The system recovers over 70 kW of heat from the 94 kW input to the compressor's electric motor. The supply from the ESP unit was connected to the boiler's feed and return headers, and the system was fitted with isolating valves that allowed the ESP or boilers to be switched in as required.

Since the installation was commissioned, the company has rarely had to operate the boiler, sufficient heat having been provided by the heat recovery system throughout the year to provide all heating requirements for the building. In addition, maintenance costs for the boiler have been reduced and the boiler can now be used as standby.

6.6 Case History 6: Short Brothers plc, Belfast

Short Brothers plc requires compressed air for process and instrumentation applications in the manufacture of parts for the aerospace industry. The compressed air system has recently been upgraded, with the purchase of two new 300 kW compressors to meet the demands of the factory. In line with the company's environmental policy, heat recovery from these compressors was considered for two applications.

The simplest application involved ducting the hot exhaust air off one compressor into the main factory area to supplement the existing heaters. During the summer months, the hot air is automatically diverted outside the factory by a motorised damper. The cost for the ductwork was low, compared with the cost of the overall compressor installation.

The other application involved heat recovery from the second compressor which had an integral oil-to-water heat exchanger. Hot water from this system pre-heats boiler water through a calorifier which feeds unitary air heaters in one part of the factory. This area requires a significant level of air extraction, and during the winter months the incoming air is steam heated by these units. Although the capital outlay for this application is higher, the benefits are greater.

Both applications for the heat recovery have achieved paybacks within the first two years of installation.

6.7 Case History 7: Baxter Healthcare Ltd, Thetford

The Baxter's site in Thetford manufactures a number of healthcare products, including IV solutions, blood donor bags and sterile irrigation fluid. Compressed air for the site is generated by four oil-free compressors and is used for a variety of process and instrument applications. The site demand for 7 barg air is typically 470 l/s (1,000 cfm).

Steam is mainly used at this site for product sterilisation purposes, with an average demand of 4,990 kg/hour (11,000 lb/hour). Approximately 70% of the steam comes into contact with the product and is deemed unsuitable for re-use via the condensate return system. The make-up is pre-heated in two stages:

- the first stage uses heat recovery from a refrigerant plant and typically supplies water at 40°C;
- the second stage uses a heat recovery system that has been retrofitted to the two lead compressors. Hot cooling water comes off the double pass after-cooler system at over 90°C and heats the make-up water via heat exchangers. Excess heat from the compressors is controlled via closed circuit cooling towers, while any shortfall in make-up water is supplied via a steam heat exchanger.

The air compressor heat recovery system was justified on a two-year payback proposal and the installation has proved successful in meeting the duty.

6.8 Case History 8 - Site: GSPK Circuits Ltd., Knaresborough

GSPK Circuits Ltd operates two factories at this site, manufacturing conventional and plated circuit boards. The compressed air for the site is generated at a central location, adjacent to the Press Shop. When a major upgrade of the compressor station was due, it was thought that much better use could be made of the waste heat.

The new compressor selected was an air-cooled oil-injected rotary screw machine, rated at 90 kW. The installation of ductwork into the Press shop air curtain on the external door for the hot exhaust air cost less than 8% of the total project. This included a bypass valve to divert the air outside during the warmer months.

Over each winter, the estimated saving in gas costs is £3,400, providing a payback for the ductwork within the first year.

The Government's Energy Efficiency Best Practice Programme provides impartial, authoritative information on energy efficiency techniques and technologies in industry, transport and buildings. This information is disseminated through publications, videos and software, together with seminars, workshops and other events. Publications within the Best Practice Programme are shown opposite.

Further information

For buildings-related publications please contact:
Enquiries Bureau

BRECSU

Building Research Establishment
Garston, Watford, WD2 7JR
Tel 01923 664258
Fax 01923 664787
E-mail brecsuenq@bre.co.uk

For industrial and transport publications please contact:
Energy Efficiency Enquiries Bureau

ETSU

Harwell, Didcot, Oxfordshire,
OX11 0RA
Fax 01235 433066
Helpline Tel 0800 585794
Helpline E-mail etbpenhlp@aeat.co.uk

Energy Consumption Guides: compare energy use in specific processes, operations, plant and building types.

Good Practice: promotes proven energy efficient techniques through Guides and Case Studies.

New Practice: monitors first commercial applications of new energy efficiency measures.

Future Practice: reports on joint R & D ventures into new energy efficiency measures.

General Information: describes concepts and approaches yet to be fully established as good practice.

Fuel Efficiency Booklets: give detailed information on specific technologies and techniques.

Energy Efficiency in Buildings: helps new energy managers understand the use and costs of heating, lighting etc.